

# **ELECTRIC LIFT TRUCK SPECIFICATIONS**

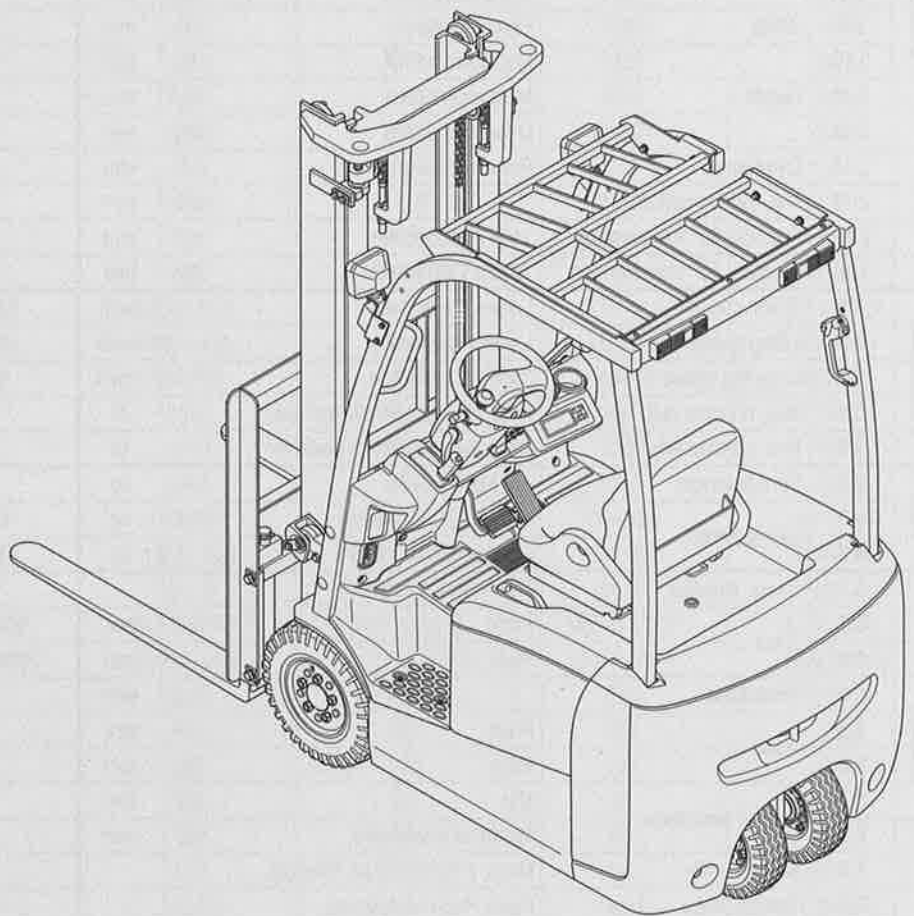

**THREE-WHEELER**

**80 SERIES**

**FBT9/10/13/15/16/18/20**

# Standard Specifications

		Item	Summary	Unit	NICHIYU	NICHIYU	NICHIYU	NICHIYU	NICHIYU	NICHIYU	NICHIYU	NICHIYU	NICHIYU	NICHIYU	
Type	1.2	Model			FBT9P	FBT10P	FBT13P	FBT15P	FBT16P	FBT18P	FBT20PN	FBT16PB	FBT18PB	FBT20PBN	
	1.3	Rated capacity	Q	kg	900	1000	1300	1500	1600	1800	2000	1600	1800	2000	
	1.4	Load center	C	mm	500	500	500	500	500	500	500	500	500	500	
	1.6	Operator type	Stand-on / Seated		Seated	Seated	Seated	Seated	Seated	Seated	Seated	Seated	Seated	Seated	Seated
Dimensions	2.1	Lift height	H <sub>3</sub>	mm	3000	3000	3000	3000	3000	3000	3000	3000	3000	3000	
	2.2	Free lift	H <sub>2</sub>	mm	115	115	115	115	115	115	120	115	115	120	
	2.3	Tilt angle	For-/Back-ward <F:Down/Up>	α/β	deg.	<Mast> 5 / 7.5	<Mast> 5 / 7.5	<Mast> 5 / 7.5	<Mast> 5 / 7.5	<Mast> 5 / 7.5	<Mast> 5 / 7.5	<Mast> 5 / 7.5	<Mast> 5 / 7.5	<Mast> 5 / 7.5	<Mast> 5 / 7.5
	2.4	Fork	Carriage			Class II A	Class II A	Class II A	Class II A	Class II A	Class II A	Class II A	Class II A	Class II A	Class II A
	2.5		Dimensions (L / W / T)	ℓ / w / t	mm	1070 / 100 / 35	1070 / 100 / 35	1070 / 100 / 35	1070 / 100 / 35	1070 / 100 / 35	1070 / 100 / 35	1070 / 122 / 40	1070 / 100 / 35	1070 / 100 / 35	1070 / 122 / 40
	2.6		Spread (Max / Min)	B <sub>3</sub> / B <sub>4</sub>	mm	920 / 240	920 / 240	920 / 240	920 / 240	920 / 240	920 / 240	1000 / 245	920 / 240	920 / 240	1000 / 245
	2.7	Length	Overall length	L <sub>1</sub>	mm	2855	2855	2855	2955	3050	3105	3175	3160	3215	3255
	2.8		to fork face	L <sub>2</sub>	mm	1785	1785	1785	1885	1980	2035	2105	2090	2145	2185
	2.9	Width	Overall width	B	mm	1090	1090	1090	1090	1090	1090	1090	1090	1090	1090
	2.10	Height	Mast lowered	H <sub>1</sub>	mm	1975	1975	1975	1975	1975	1975	1975	1975	1975	1975
	2.11		Mast extended	H <sub>4</sub>	mm	4015	4015	4015	4015	4015	4015	4000	4015	4015	4000
	2.12		Overhead guard	H <sub>5</sub>	mm	2050	2050	2050	2050	2050	2050	2050	2050	2050	2050
	2.13	Overhang	Front overhang	F	mm	375	375	375	375	375	375	415	375	375	415
	2.14	Min. turning radius		R	mm	1410	1410	1410	1510	1605	1660	1690	1715	1770	1770
	2.15	Practical 90° turning aisle <sup>(*)</sup>	1100 x 1100 Pallet		mm	1930	1930	1930	1960	1990	2000	2020	2030	2040	2050
	2.16	Practical 90° stacking aisle <sup>(*)</sup>	1100 x 1100 Pallet	As	mm	3185	3185	3185	3285	3380	3435	3505	3490	3545	3585
Performance	3.1	Travel speed	Laden / Unladen	km/h	15.0 / 16.5	15.0 / 16.5	15.0 / 16.5	15.0 / 16.5	14.5 / 16.0	14.5 / 16.0	14.0 / 15.5	14.5 / 16.0	14.5 / 16.0	14.0 / 15.5	
	3.3	Lifting speed	Laden / Unladen	mm/s	440 / 610	440 / 610	400 / 610	380 / 610	360 / 610	360 / 610	300 / 500	360 / 610	360 / 610	300 / 500	
	3.4	Lowering speed	Laden / Unladen	mm/s	550/500	550/500	550/500	550/500	550/500	550/500	550/500	550/500	550/500	550/500	
	3.5	Max. drawbar pull	3min. rating, 1.5km/h and over	N	7530	7530	7530	7390	6910	7530	7550	6910	7530	7550	
	3.6	Max. gradeability	3min. rating, 1.5km/h and over	%	20/22	20/22	20/20	18/20	15/20	15/20	14/17	15/20	15/20	14/17	
	4.1	Service weight	w/o battery (6.3)	kg	1865	1865	2075	2105	2080	2220	2595	1930	2180	2285	
Mass	4.2	Axle loading	Laden (Front / Rear)	kg	2725/490	2920/445	3460/465	3735/455	3820/445	4155/515	4650/595	4020/630	4315/785	4815/590	
	4.3		Unladen (Front / Rear)	kg	1185/1130	1205/1160	1230/1395	1245/1445	1235/1430	1245/1625	1355/1890	1505/1545	1485/1815	1615/1790	
	5.1	Tyres : Number	Front / Rear (X=Drive)		2X / 2	2X / 2	2X / 2	2X / 2	2X / 2	2X / 2	2X / 2	2X / 2	2X / 2	2X / 2	
Chassis	5.2	Tyres	Front	mm	18x7-8-14PR	18x7-8-14PR	18x7-8-14PR	18x7-8-14PR	18x7-8-16PR	18x7-8-16PR	18x7-8 (N.P.) <sup>(*)</sup>	18x7-8-16PR	18x7-8-16PR	18x7-8 (N.P.) <sup>(*)</sup>	
	5.3		Rear	mm	15x4 1/2-8-12PR	15x4 1/2-8-12PR	15x4 1/2-8-12PR	15x4 1/2-8-12PR	15x4 1/2-8-12PR	16x6-8-10PR	16x6-8-10PR	15x4 1/2-8-12PR	16x6-8-10PR	16x6-8-10PR	
	5.4	Wheelbase	L <sub>3</sub>	mm	1220	1220	1220	1320	1415	1415	1415	1525	1525	1525	
	5.5	Tread	Front	mm	920	920	920	920	920	920	920	920	920	920	
			Rear	B <sub>6</sub>	mm	250	250	250	250	250	230	230	250	230	
	5.7	Ground clearance	Min.	m1	mm	85	85	85	85	85	85	85	85	85	
			Middle of wheelbase	m2	mm	85	85	85	85	85	85	85	85	85	
	5.9	Service brake	Mech. / Hydr. / Electr. / Pneum.			Hydr.	Hydr.	Hydr.	Hydr.	Hydr.	Hydr.	Hydr.	Hydr.	Hydr.	Hydr.
	5.10	Parking brake	Foot / Hand / Deadman			Hand	Hand	Hand	Hand	Hand	Hand	Hand	Hand	Hand	Hand
	Motors	6.1	Battery	Type		BS/JIS	BS/JIS	BS/JIS	BS/JIS	BS/JIS	BS/JIS	BS/JIS	BS/JIS	BS/JIS	BS/JIS
6.2		Volts / Ampere hrs (5HR)		V/Ah	48 / 210	48 / 280	48 / 320	48 / 350	48 / 350	48 / 390	48 / 390	48 / 730	48 / 730	48 / 730	
6.3		Mass (with case)		kg	450	500	550	595	595	650	650	1120	1120	1120	
6.4		Drive motor	60min. rating	kw	2 x 4.5	2 x 4.5	2 x 4.5	2 x 4.5	2 x 4.5	2 x 4.5	2 x 4.5	2 x 4.5	2 x 4.5	2 x 4.5	
			control		Inverter	Inverter	Inverter	Inverter	Inverter	Inverter	Inverter	Inverter	Inverter	Inverter	
6.6		Hydraulic motor	5min. rating	kw	9.5	9.5	9.5	9.5	9.5	9.5	9.5	9.5	9.5	9.5	
			control		Inverter	Inverter	Inverter	Inverter	Inverter	Inverter	Inverter	Inverter	Inverter	Inverter	
6.8		Power steering motor	60min. rating	kw	0.3	0.3	0.3	0.3	0.3	0.6	0.6	0.3	0.6	0.6	
			control		Chopper	Chopper	Chopper	Chopper	Chopper	Chopper	Chopper	Chopper	Chopper	Chopper	
6.10		Charger	Type (Built-in / Stationary)		Stationary	Stationary	Stationary	Stationary	Stationary	Stationary	Stationary	Stationary	Stationary	Stationary	
6.12			Input	φ/V	3 / 200	3 / 200	3 / 200	3 / 200	3 / 200	3 / 200	3 / 200	3 / 200	3 / 200	3 / 200	
6.13			Capacity	kVA	3.8	4.7	4.7	6.5	6.5	6.5	6.5	11.0	11.0	11.0	
7.1		Operating pressure	for Attachments	MPa	13.7	13.7	13.7	13.7	15.7	15.7	18.1	15.7	15.7	18.1	

Above specifications are based on the standard truck with 3 meters simplex mast. They may vary by mast type & lifting height, tyres, battery capacity and/or warming up condition.

\*1) 200mm clearance included

\*2) N.P. : No puncture tyre

## Actual Capacities and Mast Specifications (with and without Integral Sideshifter)

Mast Type	Lift height <H <sub>2</sub> >	Mast specification (mm)					Capacities (Kg) At LC=500															Capacities (Kg) At LC=500												
		Free lift <H <sub>2</sub> >		Mast lowered height <H <sub>1</sub> >	Tilt angle	FBT9P			FBT10P			FBT13P			FBT15P			FBT16P			FBT18P			FBT20PN		FBT16PB			FBT18PB			FBT20PBN		
		9/10/13/15/16/18	20	9/10/13/15/16/18/20	α/β	Pneumatic	No Puncture	Cushion	Pneumatic	No Puncture	Cushion	Pneumatic	No Puncture	Cushion	Pneumatic	No Puncture	Cushion	Pneumatic	No Puncture	Cushion	Pneumatic	No Puncture	Cushion	No Puncture	Cushion	Pneumatic	No Puncture	Cushion	Pneumatic	No Puncture	Cushion	No Puncture	Cushion	
Two-stage full-visibility (Simplex) mast	300	3000	115	120	1975	5/7.5	900	900	900	1000	1000	1000	1300	1300	1300	1500	1500	1500	1600	1600	1600	1800	1800	1800	2000	2000	1600	1600	1600	1800	1800	1800	2000	2000
	330	3300	115	120	2125	5/7.5	900	900	900	1000	1000	1000	1300	1300	1300	1500	1500	1500	1570	1570	1600	1800	1800	1800	2000	2000	1600	1600	1600	1800	1800	1800	2000	2000
	350	3500	115	120	2225	5/7.5	900	900	900	1000	1000	1000	1300	1300	1300	1500	1500	1500	1550	1550	1570	1770	1770	1800	2000	2000	1600	1600	1600	1800	1800	1800	2000	2000
	370	3700	115	120	2325	5/7.5	900	900	900	1000	1000	1000	1270	1270	1300	1500	1500	1500	1530	1530	1550	1730	1750	1770	2000	2000	1600	1600	1600	1800	1800	1800	2000	2000
	400	4000	115	120	2525	5/7.5	900	900	900	970	970	1000	1200	1230	1270	1400	1450	1500	1450	1470	1530	1630	1670	1730	2000	2000	1600	1600	1600	1800	1800	1800	2000	2000
	450	4500	115	120	2775	3/6	870	870	900	900	900	950	1130	1150	1230	1250	1350	1400	1270	1370	1430	1400	1600	1650	1800	1800	1430	1600	1600	1500	1800	1800	1830	1830
	500	5000	115	120	3035	3/6	800	830	870	830	850	900	900	1070	1170	1050	1250	1300	1070	1270	1330	1150	1450	1550	1600	1600	1130	1450	1530	1170	1500	1600	1630	1630
Two-stage full-free (Duplex) mast	300PFL	3000	960	975	1975	5/6	900	900	900	1000	1000	1000	1300	1300	1300	1500	1500	1500	1600	1600	1600	1800	1800	1800	2000	2000	1600	1600	1600	1800	1800	1800	2000	2000
	330PFL	3300	1110	1125	2125	5/6	900	900	900	1000	1000	1000	1270	1270	1270	1500	1500	1500	1550	1550	1570	1800	1800	1800	2000	2000	1600	1600	1600	1800	1800	1800	2000	2000
	350PFL	3500	1210	1225	2225	5/6	900	900	900	1000	1000	1000	1270	1270	1270	1500	1500	1500	1530	1530	1550	1770	1770	1800	2000	2000	1600	1600	1600	1800	1800	1800	2000	2000
	370PFL	3700	1310	1325	2325	5/6	900	900	900	1000	1000	1000	1270	1270	1270	1500	1500	1500	1530	1530	1550	1730	1750	1770	2000	2000	1600	1600	1600	1800	1800	1800	2000	2000
	400PFL	4000	1510	1525	2525	5/6	900	900	900	970	970	1000	1200	1230	1250	—	—	—	1430	1470	1530	1630	1670	1730	2000	2000	1600	1600	1600	1800	1800	1800	2000	2000
Three-stage full-free (Triplex) mast	370M	3700	760	775	1775	5/6	900	900	900	950	1000	1000	1230	1270	1270	—	—	—	1470	1530	1530	1630	1750	1750	1950	1950	1600	1600	1600	1800	1800	1800	1950	1950
	400M	4000	860	875	1875	5/6	870	900	900	900	950	950	1170	1230	1230	—	—	—	1400	1470	1470	1570	1670	1670	1930	1930	1570	1600	1600	1800	1800	1800	1930	1930
	430M	4300	960	975	1975	3/6	850	870	870	870	900	900	1130	1170	1170	1250	1400	1400	1330	1430	1430	1470	1630	1630	1850	1850	1530	1550	1550	1700	1800	1800	1850	1870
	450M	4500	1030	1045	2045	3/6	830	850	850	850	870	870	1070	1150	1150	1200	1350	1350	1270	1370	1370	1350	1570	1570	1800	1800	1470	1530	1530	1530	1750	1800	1800	1830
	470M	4700	1110	1125	2125	3/6	800	830	830	830	850	850	1050	1130	1130	1150	1300	1300	1200	1330	1330	1270	1530	1530	1700	1700	1300	1500	1500	1350	1700	1730	1730	1750
	500M	5000	1210	1225	2225	3/6	770	800	800	800	830	830	900	1070	1070	1000	1250	1250	1030	1270	1270	1100	1470	1470	1600	1600	1130	1450	1450	1170	1530	1600	1600	1630
	550M	5500	1400	1415	2415	1.5/5	630	730	730	650	750	750	700	950	950	770	1100	1100	800	1130	1130	850	1150	1200	1170	1300	800	1130	1130	850	1150	1200	1170	1300
	600M	6000	1580	1595	2595	1.5/5	430	630	630	450	650	650	500	670	800	550	700	850	570	730	870	600	750	900	770	1000	570	730	870	600	750	900	770	1000
	650M	6500	1820	1835	2835	1.5/4	330	400	500	350	430	530	370	450	550	400	470	570	430	500	600	450	530	630	550	650	430	500	600	450	530	630	550	650
	700M	7000	2020	2035	3035	1.5/4	200	250	300	230	270	330	250	300	350	270	330	370	300	350	400	330	370	430	400	450	300	350	400	330	370	430	400	450

\* Mast Raised Height <H<sub>2</sub>> : Lift Height <H<sub>2</sub>> + 1015mm for FBT9/10/13/15/16/18 +1000mm for FBT20

## Aisle Width

	Pallet size	Mast type	FBT9P	FBT10P	FBT13P	FBT15P	FBT16P	FBT18P	FBT20PN	FBT16PB	FBT18PB	FBT20PBN
			Front overhang (mm)	Two-stage Mast	375	375	375	375	375	375	375	415
		Two-stage Mast w/ISF	395	395	395	395	395	395	430	395	395	430
		Three-stage Mast	400	400	400	400	400	400	420	400	400	420
		Three-stage Mast w/ISF	425	425	425	425	425	425	430	425	425	430
Practical 90° turning aisle width <sup>*3)</sup> (mm)	W1100 x L1100	Two-stage Mast	1930	1930	1930	1960	1990	2000	2020	2030	2040	2050
		Two-stage Mast w/ISF	1940	1940	1940	1970	2000	2010	2030	2040	2050	2060
		Three-stage Mast	1950	1950	1950	1970	2000	2010	2030	2040	2050	2060
		Three-stage Mast w/ISF	1960	1960	1960	1980	2010	2020	2030	2040	2060	2060
Practical 90° stacking aisle width <sup>*3)</sup> (mm)	W1100 x L1100	Two-stage Mast	3185	3185	3185	3285	3380	3435	3505	3490	3545	3585
		Two-stage Mast w/ISF	3205	3205	3205	3305	3400	3455	3520	3510	3565	3600
		Three-stage Mast	3210	3210	3210	3310	3405	3460	3510	3515	3570	3590
		Three-stage Mast w/ISF	3235	3235	3235	3335	3430	3485	3520	3540	3595	3600

\*3) 200mm clearance included

## ■ FBT9P/10P/13P

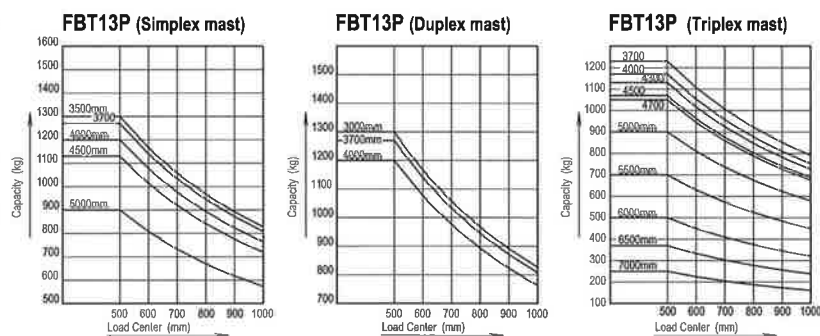
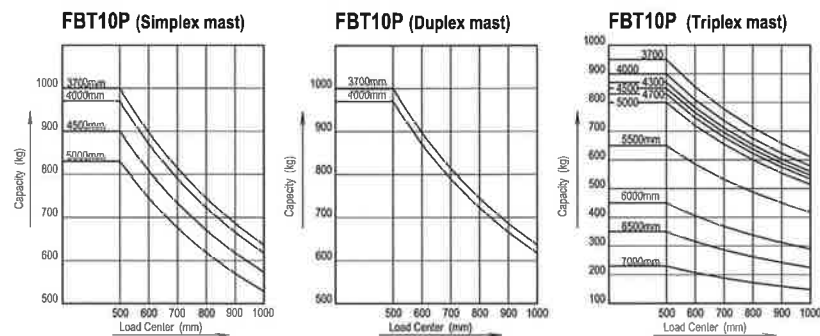
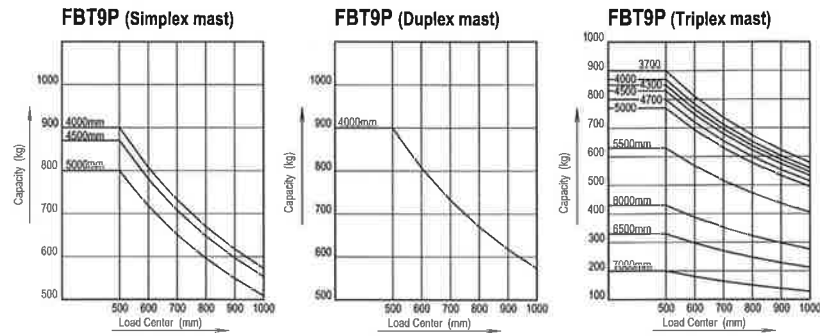
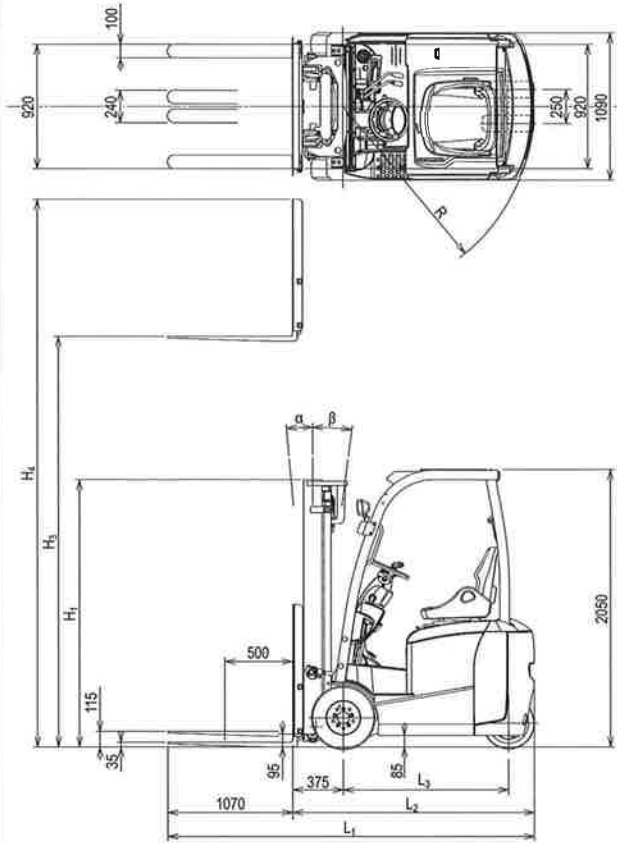

## ■ FBT15P

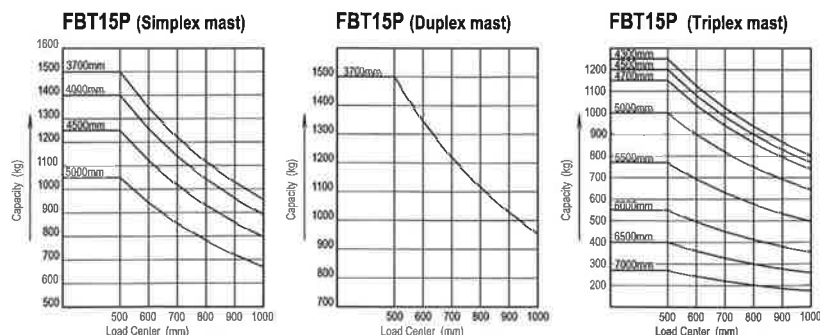
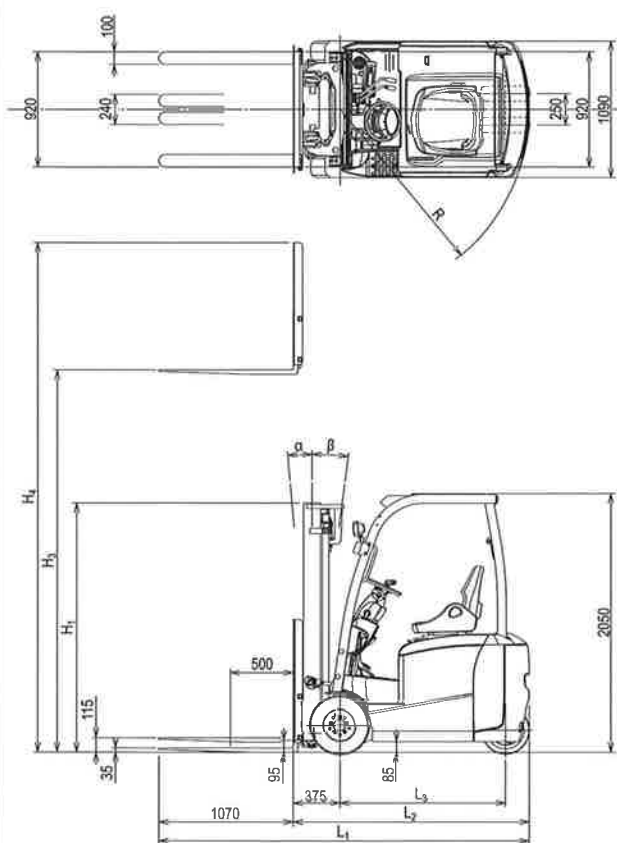

## ■ FBT16P/18P/20PN

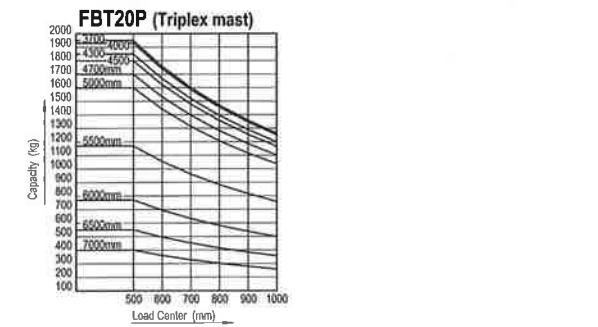
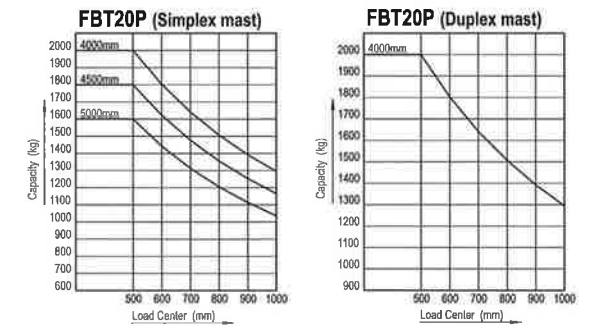
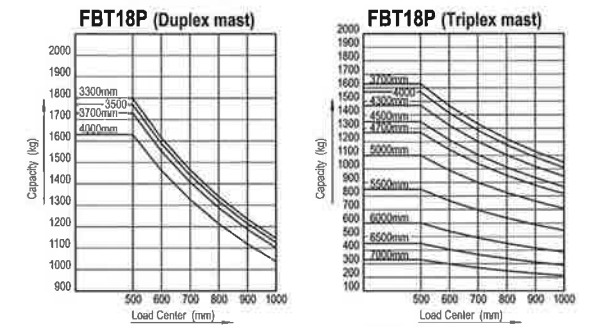
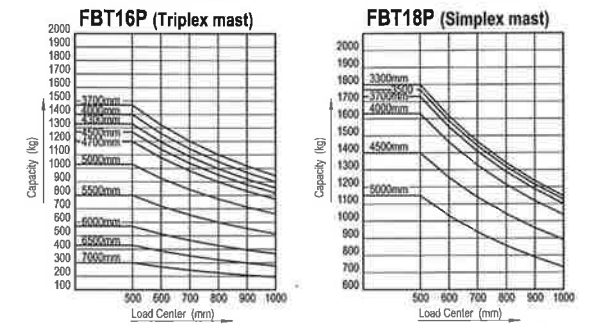
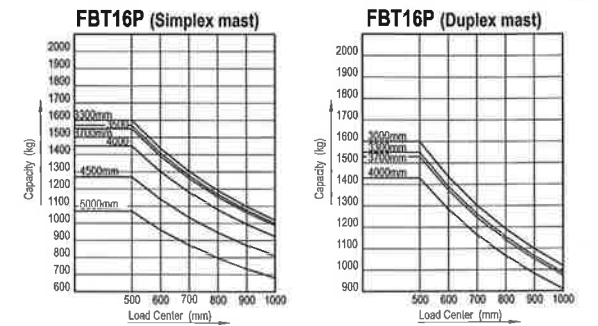
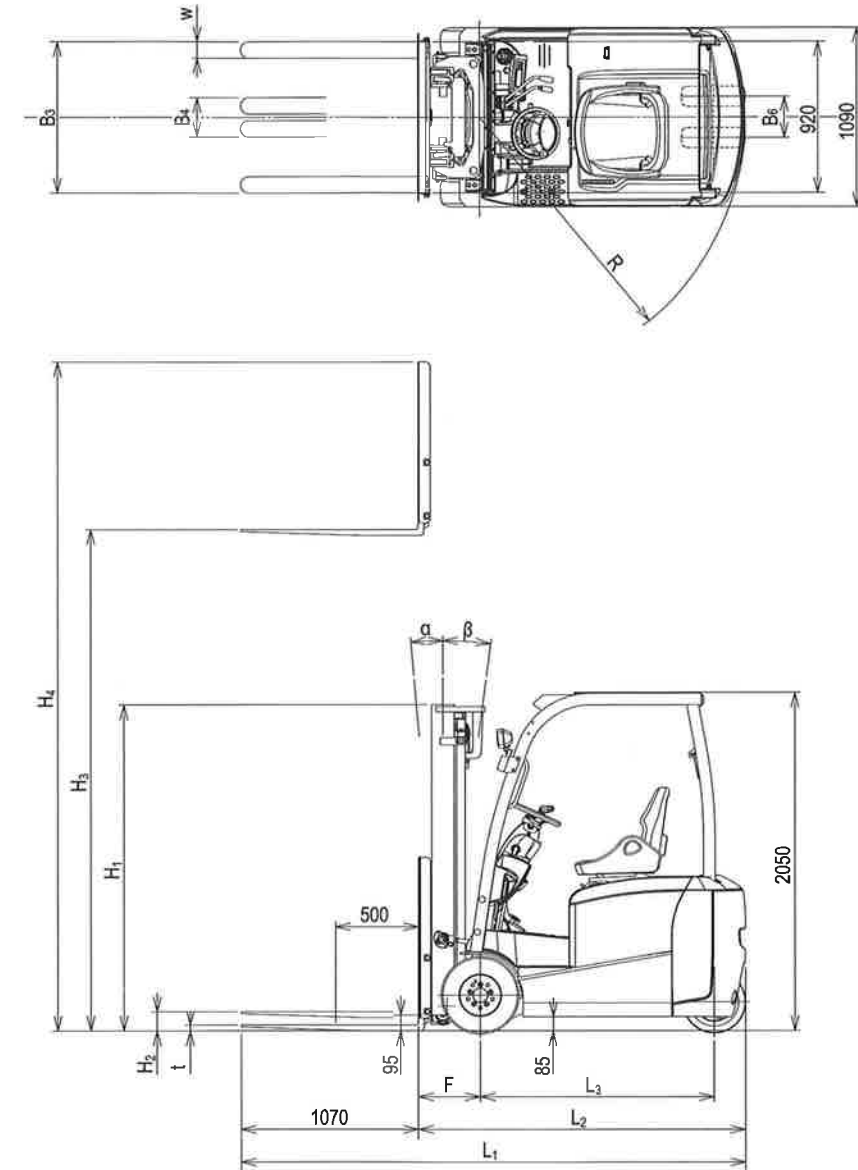

### Standard equipment

- Battery discharge indicator
- Horn
- Hour meter
- Back-up alarm
- Head lights
- Overhead guard
- Turn signal lamps
- Load backrest
- Electric power steering
- Tilt steering column

### Available batteries (5 hours rating)

- FBT9P : STD210AH
- FBT10P : STD280AH, OPT320AH, OPT370AH
- FBT13P : STD320AH, OPT370AH
- FBT15P : STD350AH, OPT390AH, 476AH, 530AH, 565AH
- FBT16P : STD350AH, OPT390AH, 476AH, 530AH, 565AH, 645AH
- FBT18P : STD390AH, OPT476AH, 530AH, 565AH, 645AH
- FBT20PN : STD390AH, OPT476AH, 530AH, 565AH, 645AH
- FBT16PB/18PB/20PBN : STD730AH

Battery capacity may vary by battery manufacturer.



# FBT16PB/18PB/20PBN

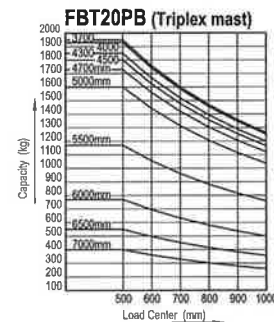
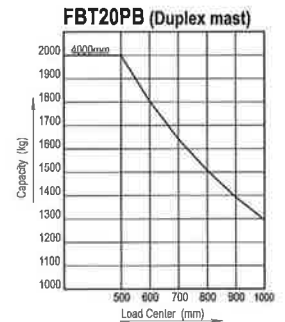
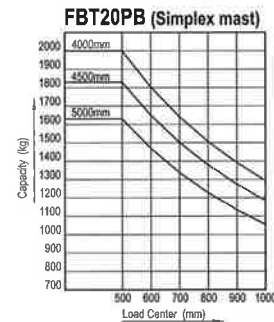
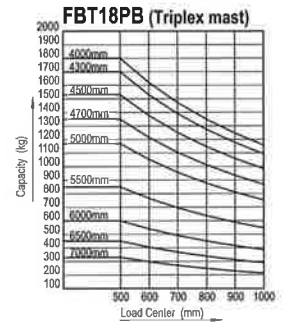
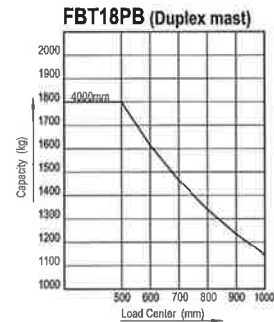
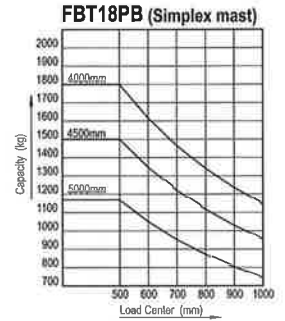
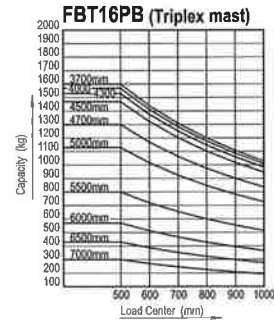
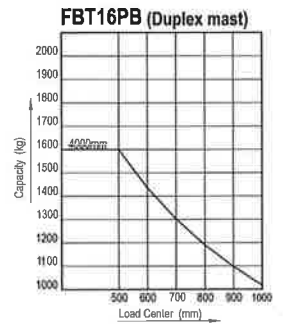
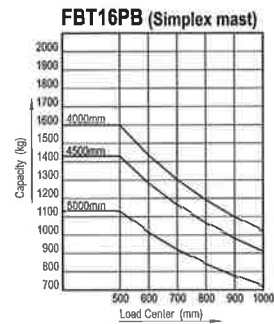
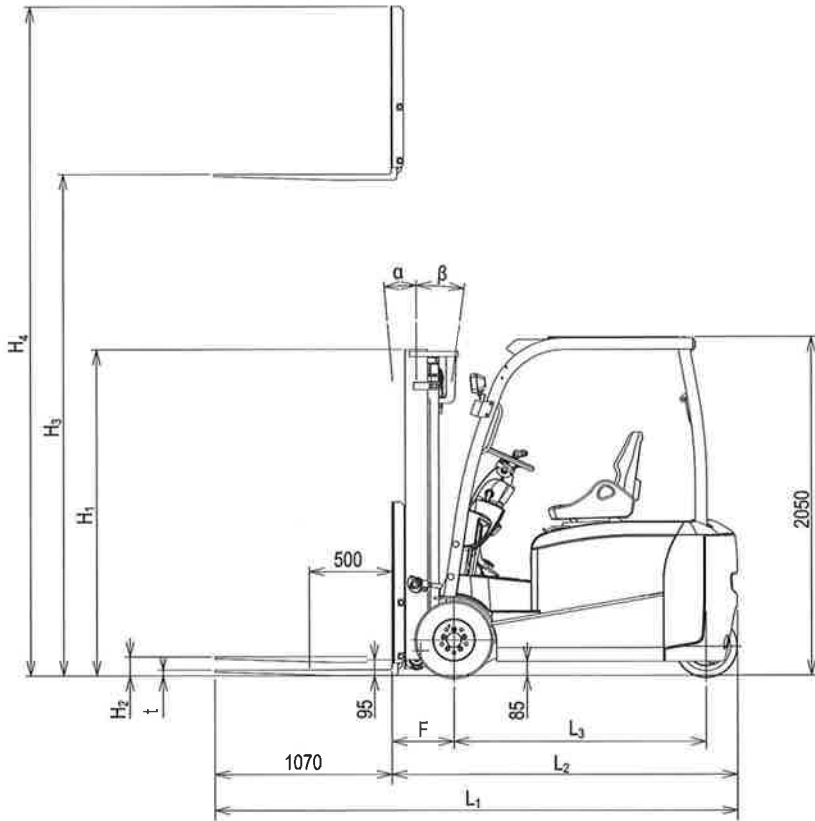
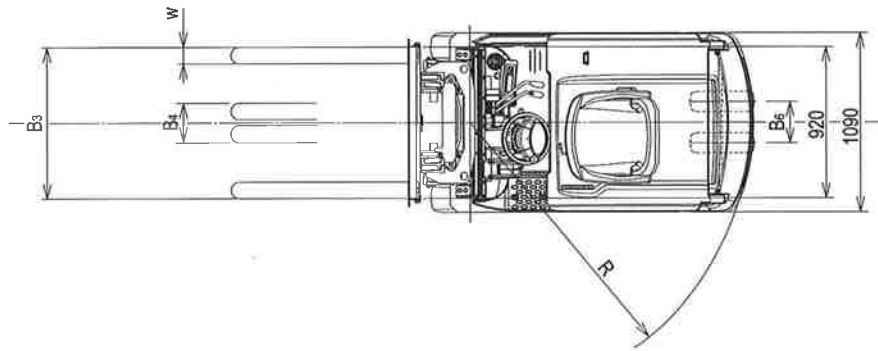

All specifications have been determined according to Nichiyu's terms and conditions. Specifications are subject to change without notice in the interests of product improvement.

# NICHIYU

Nippon Yusoki Co., Ltd.

1-1, 2-Chome, Higashikotari, Nagaokakyo-shi, Kyoto 617-8585 JAPAN  
Tel: +81-(0)75-956-8622 Fax: +81-(0)75-955-0480 URL: <http://www.nichiyunet.co.jp/en>